

Dynasty® LED Omni Light 803B Series



5 Year Warranty



Specifications

Model	803B-080W
Power Consumption	≤84W
Input Voltage	AC100-277V 50-60Hz
CCT*	3000K / 4000K / 5000K
Power Factor	≥0.9
CRI	>80
Lumen	10200±440 lm
LED	Samsung
LED Quantity	0.3W x 234 LEDs
LED LM80	Yes

* Other CCTs available upon request.



Samsung LEDs



Rubycon Capacitors



E39/EX39 Base



JAE Connectors

Dimensions

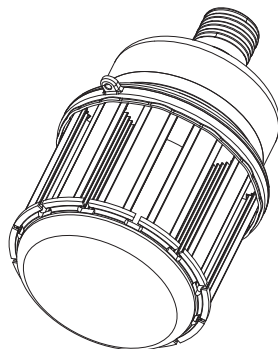
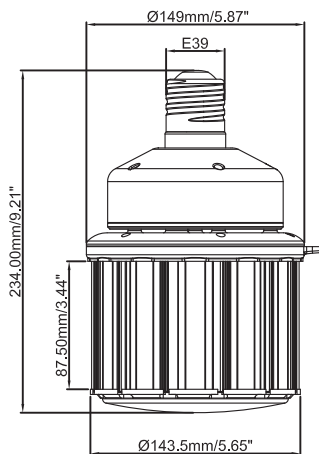

Beam Spread

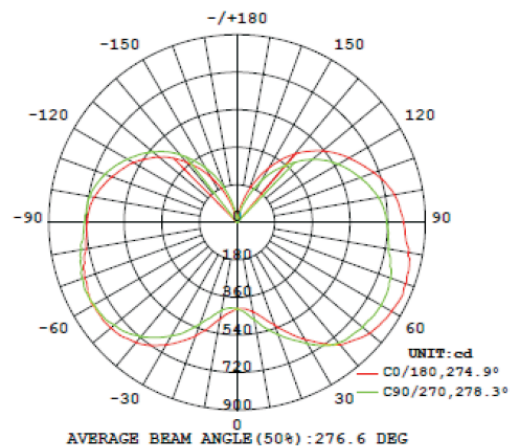

Lifespan of 10 years

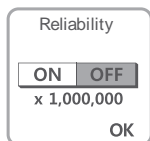

Reliability Test

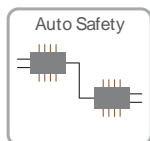

Surge Protection Circuit



Environmentally Friendly

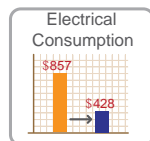

Savings of 87% on Electrical Costs

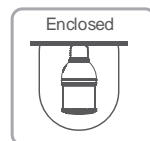

Suitable for Enclosed Fixtures



Omni Directional

Dynasty® LED Corn Light 803B Series



Typical Installation

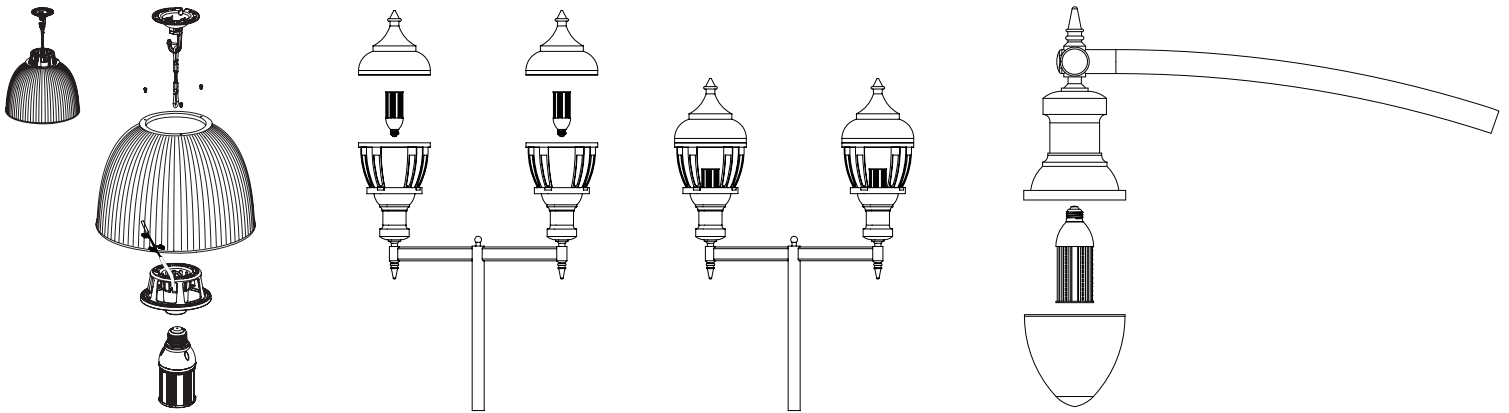

High Bay Lighting

Street Lighting / Acorn

Maximum Rating

Parameter	Rating	Units
Aluminum Heat Sink Temperature	65	C
Operating Temperature	-20~+65	C
Storage Temperature	-40~+80	C
Equilibrium Temperature	25	C

Wiring Diagram

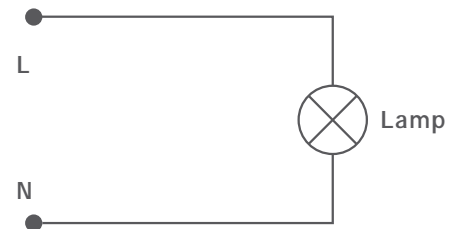

LED Omni Light Wiring Diagram

Product Packing Specification

Packing Details	
Pack Quantity	4pcs
Net Weight	3.4lbs/1540g
Gross Weight Per CTN	17.1lbs/7.76kg
Box Size	7.4*7.4*11.9" 188*188*302mm
CTN Size	15.2*15.2*12.6" 385*385*320mm

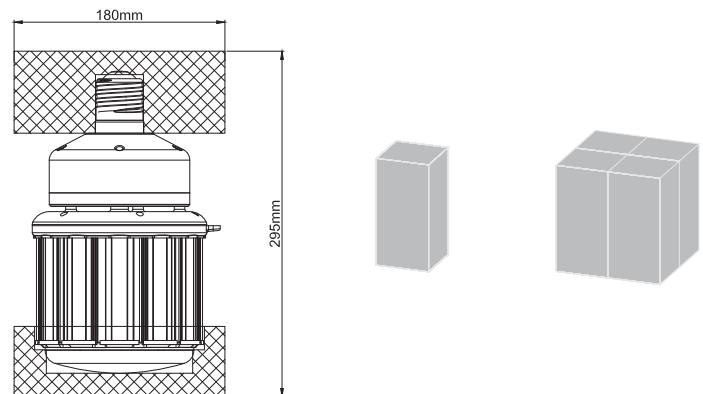

⚠ CAUTIONS

- Do not place lamp near flammable materials.
- Please allow lamp to cool before replacing.